

TUBF0304 Product Brief

1. Description

The TBUF0304 stands out as an excellent clock buffer chip capable of supporting 1.5GHz frequency across 4 outputs, showcasing ultra-low delay and jitter. It is mainly used in applications requiring low jitter, high-frequency clock / data distribution and level conversion.

It accommodates the input from 3 clock source modes: single-ended clock, differential clock, and crystal source.

The TBUF0304 can be assigned to two output groups, A and B, along with one LVCMOS output. Each channel output of A and B banks can be independently programmed to LVPECL, LVDS, HCSL or HIZ mode. Moreover, the LVCMOS clock output is synchronized with the designed clock and can be activated or deactivated.

Flexibility is a highlight of the TBUF0304, supporting a wide voltage range for both core voltage and IO voltage with compatibility for 2.5V or 3.3V power supplies.

2. Features

- Two inputs support including Single-Ended, Differential and Crystal
- 4 outputs support three modes including LVDS, LVPECL and HCSL
- Up to 1.5GHz Output Frequency for Differential Outputs

- Up to 200MHz Reference Output for LVCMOS
- Ultra-low Measured Jitter
- Low Delay from inputs to outputs channel
- Low Skew between outputs within different banks
- Flexible independent supply voltage of 3.3V/2.5V
- Lead-Free & Fully RoHS Compliant
- Industrial Temperature Support (-40°C ~ 85°C)
- Environment-friendly without Halogen and Antimony
- 32-pin, 5mm x 5mm QFN package

3. Applications

- IT infrastructure (servers, storages)
- Switches and routers
- Automotive electronics

4. Functional Diagram

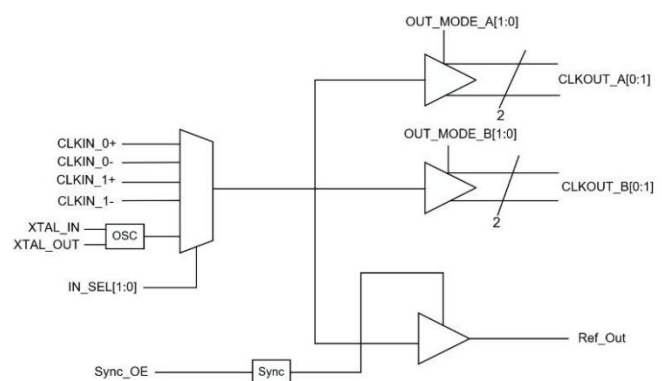

Figure 1 Functional Diagram